

# Push-Back Rack

## SYSTEM DESIGN CHEAT SHEET

**630-516-1115**  
dealersales@rmhsystems.com

PROJECT: \_\_\_\_\_

ADDRESS: \_\_\_\_\_

CITY: \_\_\_\_\_ STATE: \_\_\_\_\_ ZIP: \_\_\_\_\_

### PALLET INFORMATION

PALLET WIDTH: \_\_\_\_\_ (in) PALLET DEPTH: \_\_\_\_\_ (in)

LOAD WIDTH: \_\_\_\_\_ (in) LOAD DEPTH: \_\_\_\_\_ (in)

TOTAL HEIGHT: \_\_\_\_\_ (in) WEIGHT: \_\_\_\_\_ (lbs)

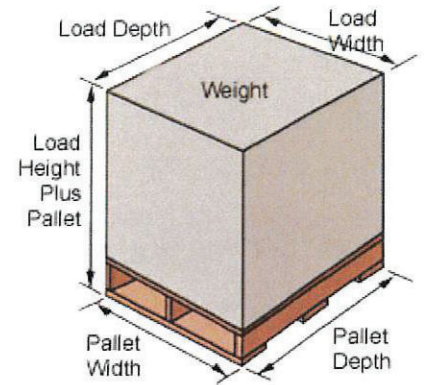

### PALLET CONFIGURATION

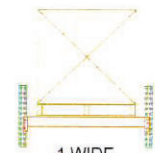

1 WIDE  
 48" TYPICAL  
 OTHER: \_\_\_\_"

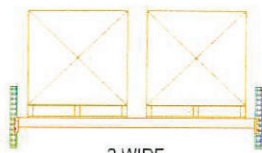

2 WIDE  
 96" TYPICAL  
 OTHER: \_\_\_\_"



3 WIDE  
 144" TYPICAL  
 OTHER: \_\_\_\_"

### SYSTEM DEPTH

2 PALLETS   
3 PALLETS   
4 PALLETS   
5 PALLETS

### BEAM CONFIGURATION

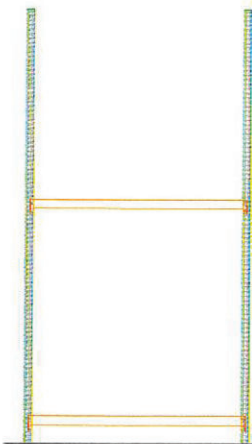

2 LEVELS

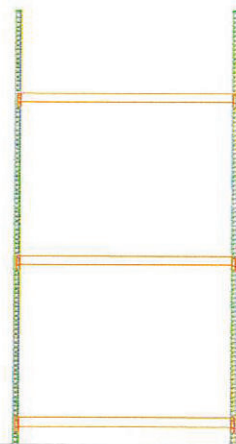

3 LEVELS

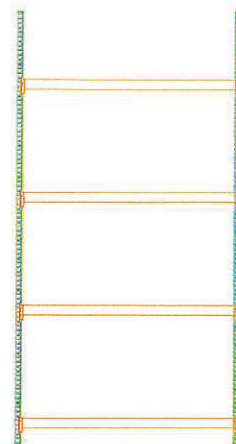

4 LEVELS

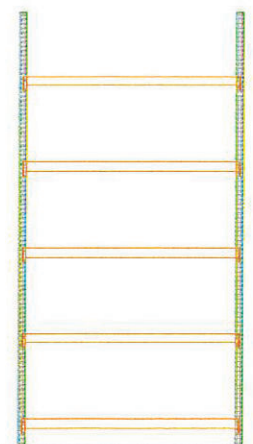

5 LEVELS